

A Paradigm Shift for a New Energy Awakening

Paul A. LaViolette, Ph.D.

The Starburst Foundation

© June 24, 2007

Our preconceived notions of what is possible and what is impossible shape and limit our ability to make new discoveries and fashion new technologies. Let us begin with Newton's Third Law of Motion—for every action there is an equal and opposite reaction. Put another way, this proposition forms the basis for the law of the conservation of momentum. Our physics books teach us that a body can only move forward in one direction by throwing mass off board in the opposite direction. This is how a rocket propels itself. But there are certain capacitor devices having asymmetrically disposed plates that are able to spontaneously move from an initial position of rest without expelling any mass; they do this merely by electrostatically charging their plates. One example is the Lafforgue field propulsion thruster.

Electric field propulsion—violation of the conservation of momentum. The Lafforgue thruster was patented in 1991 by Jean-Claude Lafforgue.¹ Unlike standard parallel plate capacitors, the Lafforgue thruster has curved non-symmetrically-disposed plates; see figure 1. When its electrodes are charged, the electric potential field that extends between them generates force vectors on the field generating electrodes. Due to the field's orientation and its diverging geometry, these induced forces will be unbalanced and as a result will yield a net residual force on the electrodes that propels the capacitor towards its T-shaped electrode. Jean-Louis Naudin has tested a 12.5 gram version of the thruster having a dielectric constant of 3.7 and demonstrated that, when charged to 7,500 volts, it moves as a result of having produced a net thrust of 18 dynes; see his webpage at <http://jlnlabs.imars.com/lfpt/html/lfptv1a.htm>.

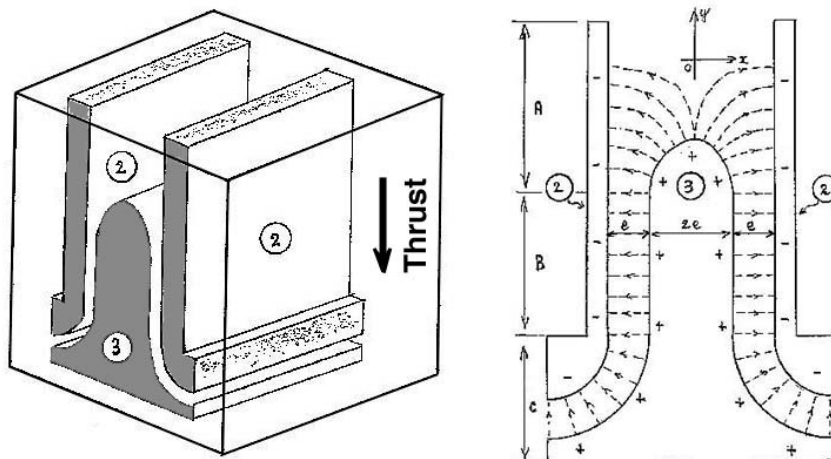

Figure 1. The Lafforgue field propulsion thruster. Its two charged electrodes, (2) and (3), are separated by a high K dielectric. Left: a three dimensional representation. Right: an illustration showing the configuration of its electric field. Forces on the positive charges are opposed to the arrow vectors (from Lafforgue's 1991 patent).

The thruster's movement presents a clear violation of Newton's Third Law. In order to uphold the principle of momentum conservation, conventional field theory would have us believe that the thruster's electrostatic field is anchored to the electrodes and that any unbalanced forces should produce internal stresses on the capacitor, but no net motion of the thruster as a whole. But in actual fact, the capacitor is found to move; momentum is not conserved. The effect becomes easily understood if the thruster's electrostatic field is not secured to the electrodes, but rather is established in the vicinity of the thruster, in the space surrounding its electrodes, thereby leaving the electrodes and the thruster as a whole free to move under the influence of the unbalanced forces that the field creates. This in essence is the explanation that Lafforgue gives in his patent.

The subquantum kinetics unified field theory also happens to predict similar behavior for its energy potential fields, in fact this may be regarded as one of its key a priori predictions.^{2,3} Several things distinguish subquantum kinetics from conventional field theory. First, it proposes that the electric field is a scalar electric potential field, and not an electric force vector field. Force on a charge emerges as a result of the action of an electric potential field gradient which is regarded as the real existent. Thus subquantum kinetics is consistent with the thinking of the nineteenth century physicists Carl Gauss and Wilhelm Weber. Furthermore subquantum kinetics proposes that this field is established in an ether medium and not in vacuuous space, the electrical potential gradient manifesting as an ether concentration gradient (X and Y etheron concentration gradients). Third, it proposes that the electric potential gradient causes forces on charges not by mechanical-like momentum exchanges, but by influencing the ether *reaction* processes that continuously create and maintain the core electric fields that compose the charged subatomic particle. Moreover this field is able to exert forces on the electrode's charges without itself suffering any recoil force. This is because the electric potential fields of subquantum kinetics form in a reaction-diffusion type ether and not in a mechanical ether of the sort proposed in the days of Faraday and Maxwell. A more in-depth discussion of subquantum kinetics, its potential fields, and how they induce force is to be found in the book *Subquantum Kinetics*.⁴

Violation of the doctrine of relativity. In subquantum kinetics, all reference frames are not equivalent. The reference frame of the ambient ether always has a unique status as the base reference relative to which all others are in motion. Any reference frame that moves relative to the ether may be known to be moving by its occupants since they can conduct a light interferometry experiment, such as the Silvertooth experiment, by means of which they can detect their motion relative to the ether ambient, or relative to an absolute reference frame in space. The idea of an absolute reference frame of course contradicts the central claim of the special theory of relativity. But, the special theory of relativity was disproved decades ago on observational grounds. A few experiments that come to mind include the Sagnac experiment, the Silvertooth experiment, and the findings of Pappas and Graneau which support the Ampere electrodynamic force law over the relativistic Biot-Savart law. A review of these disproofs of special relativity may be found in the books *Subquantum Kinetics* (ch. 1) and *Genesis of the Cosmos* (ch. 12).^{5,6} Also one is urged to read the excellent repudiation of special and general relativity written by Björn Överbye entitled "Warped Minds, Bent Truths."⁷

It is important to keep in mind that subquantum kinetics does not oppose the existence of "relativistic" effects such as Lorentz contraction and time dilation. In fact, all of the effects traditionally ascribed to special and general relativity emerge as consequences or corollaries

of the basic subquantum kinetics postulates. However, there are some differences between the two concepts. Unlike relativity, subquantum kinetics does not require that the metrics of space or time change, rather the predicted effects involve changes in the lengths of measuring rods and in the rates of clocks, without space or time itself changing. Another difference concerns the issue of relative vs. absolute reference frames. In relativity, velocity-induced, special relativistic effects are claimed to occur in identical fashion in reference frames moving relative to each other, whereas in subquantum kinetics these effects occur only in a reference frame moving relative to the ambient ether. Hence subquantum kinetics avoids the time dilation paradox in which two observers residing in each of two frames that move relative to one another will each claim that the other's clock is keeping time slower. But both cannot simultaneously be correct. As another example, consider two rocket ships that leave Earth in opposite directions traveling for many years at the same speed, close to the speed of light, and finally return. Relativity holds that terrestrials will expect that each space traveler should have aged less than themselves, but the space travelers will expect that it is the terrestrials who should have aged less, since it was Earth that moved at a relativistic speed relative to their own spaceship frame. In addition, each space traveler will claim that his counterpart space traveler has aged even less than Earthlings since he was departing and returning at an even greater relativistic speed. The result will be that fights will break out among all the relativists as each will claim that their colleagues were incompetent scientists and did not properly keep track of time. Subquantum kinetics, on the other hand, proposes that observers on board each space ship will find that they will have aged less than people on Earth, presuming that the Earth is nearly at rest relative to the ambient ether, and each space traveler will agree that his counterpart has aged slower than Earthlings by about the same amount as himself. So everyone is happy and no one ends up fighting.

In the case of gravitational effects, general relativity proposes that masses create gravitational attraction by "warping" a four-dimensional space-time metric, whereas subquantum kinetics postulates that masses generate gravity potential gradients (G etheron concentration gradients) and that these in turn cause forces on masses by influencing the ether processes that continuously form and regenerate them. Moreover this gravity field would be able to exert forces on masses without itself suffering any recoil force. This gravitational potential also affects the mass of a body, the length of a rod, or the rate at which a clock ticks, thereby yielding phenomena such as the precession of eccentric planetary orbits, gravitational length contraction, gravitational time dilation, gravitational lensing, and the gravitational redshift. Furthermore unlike in conventional relativity, these effects are not advanced as postulates, but rather derive as corollaries of the subquantum kinetics equation system. The subquantum kinetics reaction-diffusion system was initially formulated with the aim of explaining the genesis of subatomic particles and was not advanced specifically with the objective of explaining "relativistic effects," but nonetheless the proposed reaction-diffusion system does predict the existence of such effects.

Those who might not be familiar with subquantum kinetics and may wonder how its track record compares with other theories should be aware that it has had at least 10 a priori predictions verified since it was formulated in the late 1970's and since the date of its journal publication in 1985. In the last 30 years of its existence, string theory, by comparison, has made no useful experimental predictions. Currently, there is a movement underfoot in the physics community to abandon string theory and seek an entirely new approach, preferably a theory that makes testable predictions.^{8,9} For those seeking such a new approach,

subquantum kinetics offers a very attractive choice. Not only does it have an excellent record of performance in regard to verification of its predictions but, its general systems theoretic conceptual basis places it on a sound philosophical and theoretical foundation. Namely, it takes the same systems concepts that have brought great advances in the fields of biology, sociology, psychology, chemistry, mechanics, and information theory, and applies them to field theory to revamp the disciplines of microphysics, astronomy, and cosmology which are in great need of repair.

Equally important, by allowing us to change our concepts of what is technologically possible, subquantum kinetics offers a framework for understanding newly emerging unconventional energy technologies, ones that have the capability to generate energy seemingly out of nowhere in *apparent violation* of the First and Second Laws of Thermodynamics. Thus subquantum kinetics offers us a way to create future energy and propulsion technologies that could be of real benefit to society.

At some point every concerned citizen of this world will have to make a decision—will they continue to support the current seriously flawed, outmoded physics paradigm which brings society closer to the precipice as it advocates its business-as-usual course? Or will they abandon the old guard ideas and lend their support to a new theoretical paradigm, one that changes our beliefs about what is possible and that permits us to devise technologies that will provide solutions to society's current ills?

Adoption of the subquantum kinetics potential field conception over the conventional relativistic force field conception is one example of how we can change our beliefs to adopt new, more correct concepts that allow us to invent technologies that defy the "old guard" laws of physics. The ability of a charged asymmetrical capacitor to propel itself through the induction of unbalanced forces, as exemplified by the Lafforgue thrust effect mentioned above, not only opens the door to devising an important class of energy efficient propulsion technologies but also constitutes a verification of the subquantum kinetics methodology. The force developed by the Lafforgue thruster is found to increase in direct proportion to the dielectric constant, K of the thruster's dielectric and to the square of the voltage applied to its plates.* Using a thrust calculator that Jean-Louis Naudin presents on his website, we find that it is possible to design a Lafforgue thruster that produces forces far in excess of its own weight.¹⁰ For example, a 50 kilogram thruster measuring 38.5 cm high, 8.3 cm wide, and 33 cm long, using a $K = 4000$ dielectric and charged to 100,000 volts is computed to develop the phenomenally high thrust of 680 kilograms, a force that measures almost 14 times the capacitor's normal weight!

The ability of an asymmetrical capacitor to develop a very substantial pondermotive force when charged was also researched by Townsend Brown in the mid 1950's and early 60's. One electrokinetic device he tested was similar to that shown in figure 2. This diagram is based on an illustration in his 1965 patent, although his patent does not show the electrode force vectors or present a discussion of their imbalance.¹¹ It just underscores the importance of creating a nonlinear field in the space between the capacitor plates. An in depth analysis of the electrostatic forces on Brown's rig is presented in my book *Secrets of*

* This is because the electrostatic force on its plates scales according to the surface charge density on the plates which in turn increases linearly with the capacitor's dielectric constant. Also since an increase in the voltage differential across the plates both proportionally increases the surface charge density on the plates and the electric potential gradient acting on this charge, the force will scale according to the square of voltage.

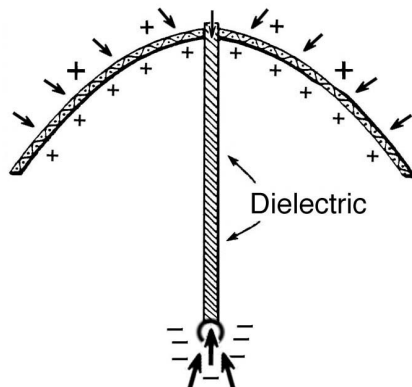

Figure 2. Asymmetrical capacitor tested by Townsend Brown. The arrows show directions in which the electric potential field gradient acts on the electrodes charges (© LaViolette, 2008).

Gravity Control, which reviews a variety of gravity control technologies.¹² As explained there, the unbalanced force field propulsion concept that Brown pioneered is believed to be in use today in propelling the B-2 bomber. The military does not mind if a new technology breaks the laws of conventional physics. If it works and has a military application, it will ultimately be employed, most likely in some black budget project. Out-of-the-box technologies are particularly attractive for the added ease of maintaining secrecy. For what better way to maintain secrecy over the military application of a new technology than if standard physics, as taught in academia, maintains that the existence of such a technology is totally impossible.

Electrogravitic field propulsion challenges general relativity and Newton's Third Law. Another phenomenon that standard physics would regard as patently impossible is the so called Biefeld-Brown effect, the tendency of a capacitor when charged to a high voltage to gravitationally propel itself in the direction of its positive pole; see figure 3.¹⁴ This phenomenon is another field effect researched by Townsend Brown which, like the unbalanced electric force effect, violates the conservation of momentum. Since the capacitor's displacement is independent of its mass, one is led to concur with Brown that the force is gravitational in nature, or more specifically *electrogravitic* since it is being electrically induced. Brown had conducted a series of vacuum chamber experiments in Paris in the late 1950's in which a pair of his capacitor thrusters arranged at opposite ends of a rotor arm caused the rotor to revolve at high speed when energized. This and other tests demonstrated that thrust was gravitic in nature and not due to ion wind effects.

The existence of this electrogravitic phenomenon suggests that electric and gravitational fields must be coupled with one another at very low energies, i.e., with substantial effects being evident in the kilovolt energy range. This undoubtedly leaves most old guard physicists totally baffled since unified field theories that attempt to salvage general relativity predict that such coupling should exist only at energies far higher than those reachable by the world's most powerful particle accelerators.

It is also apparent that the electrogravitic phenomenon challenges Einstein's general theory of relativity. Einstein conversed with Brown during 1941 when Brown was working

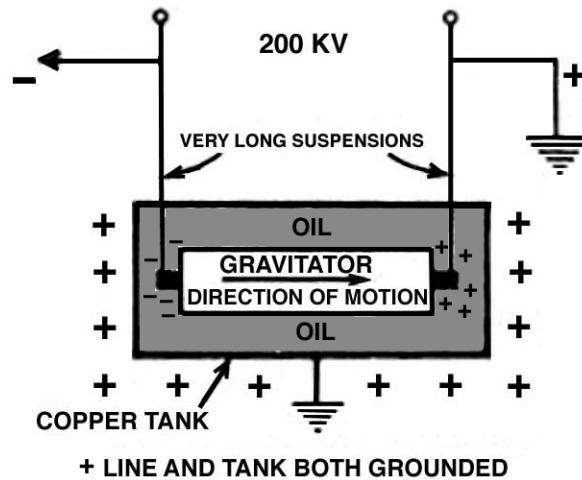

Figure 3. Electrogravitic pendulum experiment carried out by Townsend Brown.

at the Bureau of Ships in Washington.¹³ So, apparently he was familiar with Brown's electrogravitic work. This may have been the impetus behind Einstein's effort to devise a unified field theory that would find a link between the electrostatic and gravitational field. Einstein, however, failed in his attempt. Finding such a linkage would have proven to be a difficult task since general relativity involves the production of only attractive gravitational forces induced through an unexplained, almost mystical warping of space-time, whereas the electrogravitic phenomenon involves the action of either attractive or repulsive gravitational forces, these being correlated with positive or negative electric charge polarity.

Interestingly, subquantum kinetics predicts the existence of such an electrogravitic linkage, one that should be present even at low electric field potentials. In fact, it is the only theory known to do this. In the early 40's Brown had attempted to devise a theory to explain the electrogravitic phenomenon, as presented in his notebook essay entitled "The Structure of Space."^{15, 16} But this was devised as an attempt to reason a posteriori from the known phenomenon. It is significant that in his theory he envisioned gravitation as an etheric phenomenon, as an induced variation in the permittivity or permeability of free space and not as a space-time warping effect.

In recent years Patrick Cornille has undertaken a program of research to duplicate Brown's capacitor pendulum experiment.¹⁷⁻¹⁹ He used two nylon lines to suspend from the ceiling two, half-kilogram spheres, separated from one another by a dielectric rod. When he applied a charge differential to the spheres of between 30 to 50 kilovolts DC, this double sphere pendulum swung toward its positive pole. Cornille concurs with Brown that ion wind effects cannot explain the pendulum's thrust and has concluded that the phenomenon represents a real violation of Newton's Third Law.

The Podkletnov gravity beam generator challenges relativity and Newton's Third Law. Another electrogravitic device worth mentioning is the gravity beam generator developed by Eugene Podkletnov. This device discharges a ten megajoule 2000 kilovolt charge through a 10 centimeter diameter superconducting cathode to an anode. The beam generator experiences no net recoil during its operation.²⁰ As expected, the back momentum

produced when the electrons are ejected from the cathode is counterbalanced by the forward momentum produced when the electron stream is absorbed in the anode. Yet, the 10 centimeter diameter gravity wave pulse that moves forward through the generator's anode produces a repulsive *longitudinal* gravitational thrust on all matter it encounters along its path. Podkletnov and Modanese found that a single gravity wave pulse was able to cause a 1.5 centimeter diameter, 18.5 gram pendulum bob suspended at the end of an 80 centimeter cord to swing 14 centimeters.²¹ This indicates that the bob had acquired an impulse of 900 g cm/s. If this same gravity beam pulse were allowed to pass through a 10 centimeter diameter concrete beam having a length of 5 meters, the acquired momentum impulse would be about ten thousand fold greater, or about 100 Newton-seconds (10^7 g cm/s). This occurs as a blatant violation of the law of conservation of momentum.

This violation is not a problem in the subquantum kinetics paradigm. Subquantum kinetics predicts that the shock discharge emitted by Podkletnov's beam generator travels forward as a "Coulomb wave" characterized by a longitudinal electric potential gradient accompanied by a longitudinal gravity potential gradient which is generated as a result of the inherent coupling between electric and gravitational fields.^{22,23} As is the case with the electrostatic fields produced in the Lafforgue thruster, this propagating gravity field gradient (or gravity wave) induces its repulsive force with no back recoil either on the gravity wave or on the wave generator apparatus that initially produced it.

The findings of Podkletnov and Modanese also call into question the general relativistic notion that gravity waves are transmitted as transverse quadrupolar waves. For the waves from Podkletnov's beam produce no lateral motion of the pendulum bob, only a forward swing. Furthermore, like Townsend Brown's electrogravitic findings, this experiment demonstrates that there is an observable coupling between electric and gravitational fields in the kilovolt range, thereby adding to the bafflement of those proposing relativistic unified field theories. Adding insult to injury, the gravity waves that this apparatus produces travel forward at a superluminal speed, experimentally clocked at upwards of $64 c$.²⁴ Subquantum kinetics proposes that this occurs because the shock propels the ambient ether forward, the shock velocity equaling c plus the forward ether velocity. Experiments carried out by Guy Obolensky and myself confirm this prediction. They have shown that diverging electric shocks depart at an initially high superluminal speed that gradually decreases toward c as the shock front spreads out and its ether wind inducing gravity gradient progressively declines.²⁵

Electric field propulsion—violation of energy conservation. Let us return once more to the Lafforgue thruster to see how it fairs with the energy conservation law. By arranging four Lafforgue thrusters in pinwheel fashion about an axis, one can produce a motor that is able to generate a tremendous torque. Spinning at 5250 rpm, this electrokinetic motor would be generating 12,000 horsepower, or 8.7 megawatts of power.²⁶ Accounting for efficiency losses in the electrical generator and bearing resistance, a motor-generator combination should be capable of producing 5 megawatts of power. If enclosed in an evacuated chamber, the only energy loss from these thrusters would be the leakage current through their capacitor dielectrics, and since high-K dielectrics such as barium strontium titanate have very high dielectric strengths, the power consumed to operate all four thrusters will be very small, about four watt at this 100 kilovolt potential. Obtaining an output of 5 megawatts for an input of 4 watts implies an output-to-input ratio in excess of a million to

one. Clearly this violates the First Law of Thermodynamics in a very big way. So, now standard physics has an additional anomaly to contend with, not only the violation of the conservation of momentum, but also the violation of energy conservation.

The energy conservation law is one of the most sacred tenets of contemporary physics. Its violation is particularly problematic to the conventional paradigm since standard physics views the physical world of matter and energy quanta as a closed system. Within this black box, any energy gained in one part of the universe must be taken from some energy source elsewhere in the universe. To contend with the reality that a field propulsion motor can propel itself and in so doing spontaneously create energy with no apparent physical input, contemporary physicists can either go into a state of shock, enter a psychological state of denial, or they can acknowledge the pain and make a concerted effort to radically revise their theoretical constructs.

Overunity energy production, however, is not a problem for subquantum kinetics which models the observable physical world as an open system.^{27,28} It postulates that all material particles, fields, and energy waves are epiphenomena, concentration patterns, formed in an underlying ether substrate that engages in irreversible transformation along a fourth dimension. This reaction-diffusion ether consists of innumerable ether states, three of which (X, Y, and G) serve as substrates for the electric and gravitational fields that compose our physical universe, the others residing either "above" or "below" these three along this fourth transformation dimension. Hence this unseen etheric flux continually passes through our universe entering and ultimately leaving our physical universe as it proceeds along this "transformation dimension, our physical universe, which is underlain by the X, Y, and G ethers, being a very minor nexus in this higher dimensional reactive flux. Subquantum kinetics further proposes that the negentropic states of the subatomic particles and fields that compose our observable world are continually sustained by this transmutative flux and that this flux is what gives our universe its open character. All of this accords with the teachings of eastern mysticism and western gnosticism.²⁹

The Second Law of Thermodynamics holds only for closed systems. Open systems, on the other hand, can spontaneously decrease their entropy, i.e., create order out of disorder. According to subquantum kinetics, then, it is possible for the entropy of the universe to spontaneously decrease, and energy need no longer be strictly conserved. Thus matter creation is entirely permissible as a gradual ongoing process, avoiding the contradiction inherent in the Big Bang theory which founds its cosmology on an immense momentary violation of the First and Second Laws.

The amount of potential energy characterizing a photon or a zero-point energy fluctuation is able either to increase or decrease over time depending on whether the reaction system operates in the supercritical or subcritical mode. Thus perfect energy conservation is a special case that is rarely observed, while gradual energy creation or gradual energy destruction is a commonplace event. Nature's violations, however, are normally so small that they are virtually undetectable in the laboratory, appearing large enough only when considering phenomena on an astronomical scale. Subquantum kinetics proposes that matter is being continuously created from energy potential fluctuations that constantly emerge from the ether, and that this process is responsible for the creation of our material universe. Although these ongoing creation events constitute energy conservation violations, they come nowhere near in magnitude to the violation required for the alleged Big Bang.

In subquantum kinetics there is no need to introduce any ad hoc singularity creation event. It conservatively assumes that space is Euclidean and cosmologically static. The galaxy redshifts, which big bang cosmologists interpret as evidence for cosmological expansion, instead arise in a natural and totally expected fashion, since photons that traverse intergalactic stretches of space, where the ether reaction system operates primarily in a subcritical state, are predicted to lose energy. As shown elsewhere, this tired-light cosmology fits observational data better than the expanding universe cosmology.^{30,31} The subquantum kinetics requirement that photon energy should be gradually increasing in the supercritical regions of space that surround each galaxy has been confirmed by the discovery of the planetary-stellar mass-luminosity relation, the finding that red dwarf stars, brown dwarfs, and jovian planets share a common M-L relation; see Figure 4.^{32,33} The

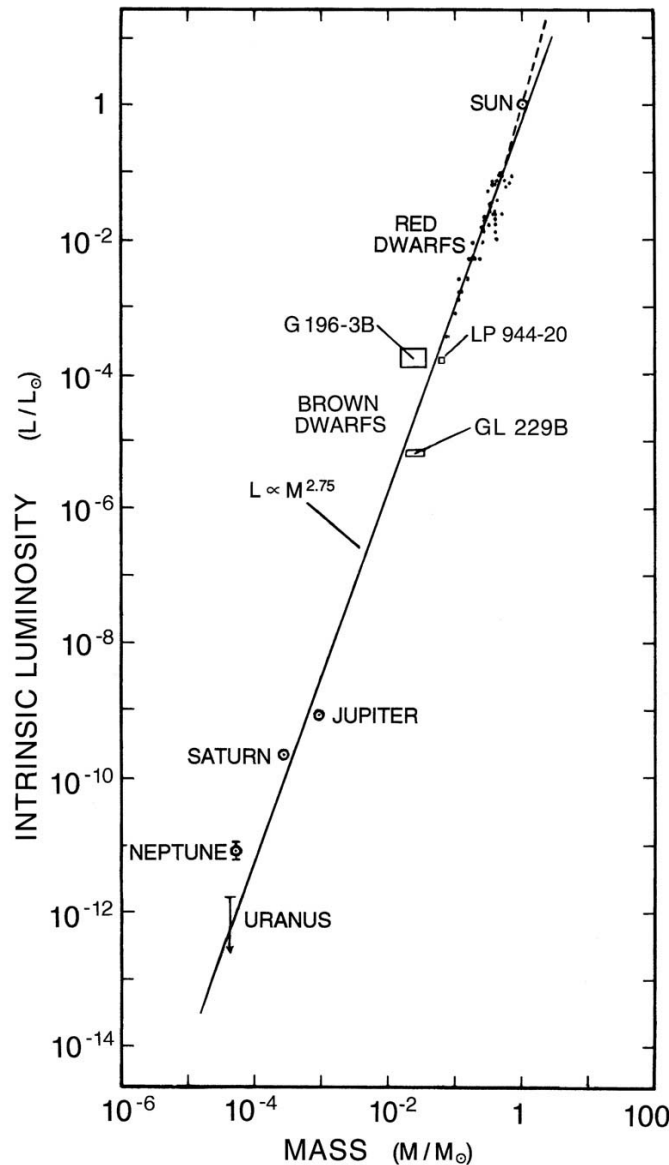

Figure 4. Planetary-stellar mass-luminosity relation discovered when testing the subquantum kinetics genic energy prediction (LaViolette, 2003).

exponent of this log mass — log luminosity relation is consistent with the subquantum kinetic prediction. The M-L data predicted a photon energy amplification rate of approximately $1.1 \pm 0.6 \times 10^{-18} \text{ s}^{-1}$ for signals traveling through the outer solar system, and this prediction was later confirmed by observations of maser signals transponded to the Pioneer spacecraft. This phenomenon has come to be known as the Pioneer Anomaly.³⁴

Cold fusion—challenges conventional theories of the nuclear field. Low temperature nuclear transmutation is another phenomenon that has puzzled physicists. This is the observed release of excess heat, gamma rays, thermal neutrons, and tritium gas when an electric current is passed through a palladium electrode saturated with heavy water. Shortly after the phenomenon was first discovered in 1989 by two U.S. scientists, Martin Fleischman and Stanley Pons, members of the physics establishment began a campaign to discredit their work and deny its plausibility. The two were forced to leave the country. The U.S. Department of Energy convened a panel of scientists who concluded that the phenomenon was bogus, and based on their recommendations DOE decided not to fund any further research on the subject. Robert Park, Director of Public Information for the American Physical Society and author of the "What's New" weekly news column posted on the APS website, made cold fusion one of his favorite topics of ridicule.

Park's attacks went beyond mere name calling. In the spring of 1999, an alternate energy conference was scheduled to be hosted by the U.S. State Department. But, seeing that the conference was to include a paper on cold fusion research, Park together with Peter Zimmerman, an APS member and high ranking State Department employee, proceeded to get the entire conference canceled. This was followed by a witch hunt in which Park publicly ridiculed the organizer of the conference as well as another supporter who had publicized the upcoming conference on his personal website. Both were patent examiners at the U.S. Patent Office. After numerous APS colleagues and lobbyists circulated Park's disparaging postings to upper level management at the Patent Office, the two examiners were summarily fired from their jobs. At the 1999 Spring APS meeting during a session on "Pseudoscience" which he chaired, Zimmerman called on all attendees to report any incidents in which they might be aware of three or more colleagues convening to discuss cold fusion. Hence we find tactics being used that rivaled the McCarthy era of the 1950's. Despite the physics Mafia's vicious attempts to suppress interest in the phenomenon, cold fusion was later publicly vindicated. In 2002, the U.S. Navy published a study which summarized classified research they had been conducting on cold fusion between 1991 and 2001.³⁵ Their final conclusion was that the phenomenon was real.

Part of the reason that the phenomenon was viewed dubiously for so many years was that it was not easily reproducible. Also admission that the phenomenon was real ran counter to the ingrained belief among physicists that nuclear reactions are only possible at very high temperatures and pressures, as might exist in a nuclear fireball or at the center of the Sun. This hot fusion conception, in turn, was reinforced by their misguided belief that the electric field at the center of the nucleon rises steeply in the form of a sharp cusp and that the resulting force of electrostatic repulsion should prevent room temperature nucleons from approaching each other close enough to allow fusion to occur.

Subquantum kinetics, however, predicts an entirely different field profile for the nucleon, one that plateaus at the nucleon's center to form a Gaussian-like potential hill which in turn is surrounded by a stationary wave pattern whose wavelength equals the particle's Compton

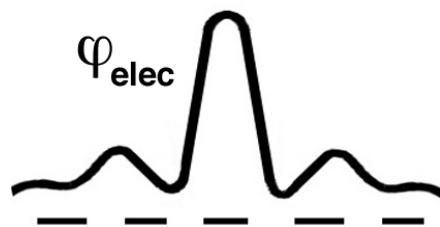

Figure 5. Sketch of the electric potential field in the core of a nucleon.

wavelength; see figure 5.^{36,37} I term this the subatomic particle's "Turing wave" in recognition of Alan Turing who in 1952 was the first to note that reaction-diffusion systems could spontaneously organize their constituents into wave patterns.³⁸ Although Turing was concerned mainly with biological morphogenesis, the same concept is applicable to microphysics.

Martin Fleischman was of the opinion that modeling the nucleon's field as having a Gaussian shape would overcome theorist's objections to the possibility of low temperature nuclear transmutation.³⁹ Indeed, the Gaussian nuclear fields of subquantum kinetics offer a defense against the repulsive force objection advanced by skeptics. But, it is now more than just a theory. The subquantum kinetics Turing wave model was independently confirmed in 2002 by an attempt to map the charge density distribution in the core of a neutron and proton by modeling particle scattering data.^{40,41} The wave pattern that surrounds the Gaussian core may also play an important role in the cold fusion process. Subquantum kinetics had proposed that nuclear binding simply involves the mutual interlocking of two electric potential Turing waves, each wave pattern forming a series of concentric energy potential wells. Hence it becomes understandable how an incoming low-velocity nucleon might become trapped in one of these wells and ultimately bound to its host, and vice versa. Ampere forces may also play a role. As professor Panos Pappas has pointed out, like charged particles in bulk motion, e.g. in a spark discharge, may actually attract one another as their Ampere electrodynamic forces could exceed electrostatic repulsion.⁴² Considered all together, this newly emerging theoretical foundation could pave the way toward widespread acceptance of the cold fusion phenomenon.

The hydrino zero-energy state challenges conventional atomic theory. Randall Mills has discovered a chemical process which induces the hydrogen orbital electron to drop to an energy level below the Bohr orbit ground state, releasing a 13.6 electron volt ultraviolet photon. He terms the resulting low-energy state hydrogen ion a "hydrino hydride." Mills' company BlackLight Power Corporation has developed a high power density, high temperature hydrogen gas cells that uses this process to produce power at least an order of magnitude greater than that of the combustion of hydrogen and at temperatures of 700° to 1200° C. They envision that the technology can be used for generating thermal energy for heating, electrical power, and propulsion. Even though the validity of this technology was independently verified at numerous research centers, Mills came under attack from the physics establishment. More specifically, beginning in the early 1990's and continuing for over a decade APS henchman Robert Park repeatedly ridiculed Mills and his hydrino concept in his "What's New" internet column.

On February 15, 2000 the U.S. Patent Office issued a patent to BlackLight Power which was to protect one aspect of their technology. But having got wind of the patent's issuance,

Park immediately shot off a news item that scathingly attacked the Patent Office for doing so. The Patent Office was apparently barraged by the emails from Park's followers and, out of embarrassment, USPTO management ordered that the patent be withdrawn even though it had already been published in the Patent Gazette.⁴³ Apparently, the BlackLight patent was rejected not because of any flaw of its technology or conflict with prior art, but because Robert Park and his APS establishment disapproved of its issuance. Appeasing the APS lobby seems to mean more to Patent Office management than providing intellectual property protection for energy solutions that could potentially avert global warming. As a result, BlackLight Power experienced a severe financial setback. This fiasco occurred just as they were about to launch an initial public offering of their stock. Moreover it threw the company into a protracted and costly legal battle against the Patent Office and its corrupt management personnel who considered lying to be morally acceptable provided that they would ultimately win.

Clearly, the notion that there might exist an energy level below what had traditionally been thought to be the ground state energy level of the hydrogen atom would be shocking to most physicists and chemists. The energy level that Mills claimed to have discovered would be one in which the hydrogen atom electron has lost all of its kinetic energy and is no longer orbiting the proton nucleus. This poses a distinct problem for standard quantum theory which regards the electron and proton both as mass points or, in the case of the proton, as three mass points due to the belief that it is formed of three quarks. The incessant probabilistic dance of these mass points is believed to produce electric fields that rise precipitously toward the particles' centers. So if the electron is no longer orbiting the proton, what keeps it from falling in toward the proton and eventually colliding with its quark mass points? The prospect raises uncomfortable questions for the physicist. Would the electron just repeatedly bump up against the proton, or if it collided, would it combine with the proton by engaging in some kind of fusion reaction? Since either scenario would not be satisfactory, the quantum theorist might be inclined to totally deny the possibility of the hydrino state altogether and instead question Mills' credibility.

With subquantum kinetics, however, one comes to an entirely different conclusion about the zero-velocity coexistence of an electron and proton. Subquantum kinetics does not model subatomic particles as mass points but as etheric wave patterns, or to use the systems theoretic term, as dissipative space structures. So a proton's electric potential Turing wave could theoretically coexist inside the electron's Turing wave, the Turing wave centers essentially coinciding with one another. The two particles would be essentially at rest relative to one another with the exception of oscillatory movement that arises from ambient thermal excitation. The same coincident situation would not be possible for two particles of similar wavelength, such as two protons or a proton and a neutron. This is because the Turing wave field gradients of both particles would be comparable and hence would strongly interact with one another. In the case of an electron and proton, on the other hand, the electron's Turing wave would be 2000 times greater than the proton's and its field gradient magnitudes would be 2000 times smaller. The electron Turing wave would appear merely as a potential bias to the proton's Turing wave pattern. In summary, the subquantum kinetics field theory is entirely consistent with the notion of there being a zero-velocity, non-orbital ground state for the electron.

The requirement that the wavelength of the electron's Turing wave should equal the electron's Compton wavelength also leads to the existence of Bohr orbit quantum

states.^{45,46} That is, if we acknowledge that a Turing wave pattern of wavelength λ_0 moving at velocity v through the ether sets up an oscillation of frequency $f_e = v/\lambda_0(1 - \beta^2)^{1/2}$ in the ether frame, then this oscillation should be communicated forward as a wave traveling at the speed of light c , which may be called its "velocity wave" since its wavelength, $\lambda_v = c/f_e = (c/v)\lambda_0(1 - \beta^2)^{1/2}$, depends on the Turing wave's velocity. Incidentally, the velocity wave wavelength is numerically equal to the particle's deBroglie wavelength, i.e., $\lambda_v = h/mv = \lambda_p$. Furthermore, as it orbits the proton, the electron's Turing wave will generate a rotational velocity wave. Hence to occupy a given nonradiative orbit about the proton, the electron's Turing wave velocity wave will necessarily need to fit a whole number of times within the circumference of its orbit. Hence $2\pi r = n\lambda_v = nh/mv$, which is the expression for Bohr orbit quantization. So not only does subquantum kinetics predict the electron orbital states of standard theory; it also predicts the existence of the zero-velocity state recently discovered by Mills. We may add that this velocity wave concept allows the foundations of wave mechanics to be entirely reinterpreted.

More recently, it has become increasingly difficult for skeptics to engage in their stoic denial of the hydrino phenomenon. In 2003 a well known journal published an article by Mills and Ray which reported their spectral observation of the 13.6 electron-volt emission line, this being one of the primary photon energies radiated by Mills' hydrino hydride creation process.⁴⁴ This calculates to be the amount of energy an electron would lose if it dropped from the $n=1$ Bohr orbit ground state to Mills' zero-velocity hydrino ground state.

The blasphemy of the parametric amplifier. A parametric amplifier consists of a nonlinear capacitive or inductive element such as a barium titanate capacitor, or barium ferrite magnet, which has the property that its permittivity or permeability changes with voltage. The nonlinear element is configured together with a capacitive or inductive element to form a tank circuit. By using an oscillator to excite it at two or three times its resonant frequency, the tank circuit resonantly oscillates. The voltage which the oscillator adds to the nonlinear element changes the element's permittivity or permeability, i.e., its "parameter," and by doing this at the proper phase of the tank circuit's resonance cycle it is able to amplify the resonant oscillation and boost its total amount of energy. For example, by decreasing the barium titanate capacitor's electric permittivity ϵ ; this in turn decreases its capacitance ($C \propto \epsilon$) and increases its voltage ($V \propto 1/C$). By doing this at the proper phase where the resonance cycle is approaching either a positive or negative voltage maximum, energy may be added causing the amplitude and power of the resonance cycle to increase. Parametric amplifiers are also commonly used in microwave beam systems to boost signal strength.

One interesting thing about parametric amplifiers is that their energy output can greatly exceed their energy input. The amount of energy inputted by the exciter oscillator to alter the permittivity or permeability of the circuit's nonlinear element can be much less than the amount of energy that the resonant circuit gains through the parametric excitation process. The amount of this overunity output vs. input depends on the type of nonlinear medium and its response in the frequency range used.

The Magnetic Resonance Amplifier (MRA) is an example of one such amplifier that operates in the audio frequency range. It is based on the work and theories of John Ernst Worrell Keely and has been extensively researched by hobbyists. Instructions on how to build it and descriptions of its operation are available on the internet.⁴⁷ It uses a high-K dielectric such as a barium titanate capacitor hooked in series with a coil wound around a

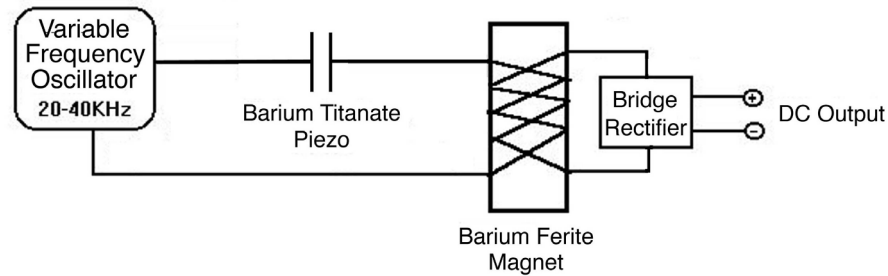

Figure 6. Schematic diagram of the Magnetic Resonance Amplifier.

barium ferrite ceramic magnet core; see figure 6. By exciting it at a frequency of around 20 to 40 kiloHertz, this nonlinear tank circuit is made to oscillate at its resonant frequency of around 8000 to 11,000 Hertz. Power is drawn from the oscillating ferrite core through a secondary winding that is connected to a bridge rectifier. One such device built and tested by Joel McClain and Norman Wootan achieved a power output of 2.75 watts for an input power of 0.7 watts, or an over-unity ratio of about 4. At resonance the voltage across the tank circuit ranged up to 1000 volts when excited with a 30 volt AC pump signal.

The overunity findings of parametric amplifiers have been repeatedly documented and independently verified. But in spite of their phenomenal results, party line physicists turn a blind eye to this evidence, for over-unity performance clashes with the sacred First Law. One is immediately presented with the question as to where this excess energy comes from. Researcher Guy Obolensky, who has built and operated an overunity parametric amplifier of his own design, suggests that a parametric amplifier is able to cohere energy from noise present at the atomic level in the amplifier's nonlinear medium and in the amplifier's immediate space environment by acting as a phase conjugate resonator. Nonlinear elements such as barium titanate or barium ferrite have the ability to phase conjugate incoming waves, in effect creating a time-reverse wave that travels back to the wave's source, thereby reversing its entropy. In so doing the parametric amplifier is able to reverse the entropy of energy waves that it has radiated and that have subsequently been reflected back from its environment. But in so doing it will reverse the entropy also of any energy that those waves may have acquired during their out-and-back journey. Thus a phase conjugate resonator is ultimately able to reverse the entropy of thermal energy in its environment and entrain it into its oscillation process. As to whether Robert Park and the self-appointed APS clergy would find this to be objectionable is anyone's guess. But, phase conjugate resonance is a well documented phenomenon that should not cause any well informed physicist to raise any objection.

Parametric amplifiers offer yet one more technology that could allow society to extricate itself from its current energy crisis. Unless the physics establishment is willing to drastically alter its fundamental concepts about physical reality, researchers who should be regarded as society's heroes will continue to be marked as an enemy. Like the witches of old they will continue to be regarded as a threat that society must eliminate. By denying the feasibility of such technologies and having the full force of society's legal system behind

them, inventors of such technologies risk being prosecuted as hoaxers or thrown into jail on trumped up charges such as the harboring of "weapons of terrorism."

The Searl Electrogravity Generator: A challenge to conventional fundamental physics.
The Searl Electrogravity Generator (or Searl Disc) was invented by British inventor John Searl in the early 1950's.⁴⁸ It consists of a magnetized stator ring around which a set of roller magnets roll and revolve in unison. Searl observed that when the rollers reached a certain speed, their revolution about the stator accelerated and that they would continue to accelerate unless power was electromagnetically drawn off. He also found that the disc would also levitate. Many of his discs would shoot upward into the sky never to be seen again. Leary of Searl's work, local authorities seized Searl's discs and threw him in jail claiming that his generators were "stealing power" from the local utility grid. Russian researchers Vladimir Roshchin and Serge Godin in the mid 90's built and tested a version of Searl's disc which they have named the Magnetic Energy Converter, or MEC.⁴⁹ Their prototype had a diameter of 1 meter and was fitted with a starter motor and braking system; figure 7. Their tests indicated that when the rotor speed surpassed about 200 rpm the MEC began to partially power itself, its drive motor accordingly consuming less power. When the rotor had accelerated to 550 rpm, the starter motor no longer consumed any current and instead began to generate output power, producing 7 kilowatts at a rotor speed of 595 rpm. They also observed that the rotor began to lose weight once its speed had exceeded 550 rpm. At 595 rpm the weight of the whole apparatus was observed to have lost 35% of its weight. The device was not tested at speeds greater than 595 rpm for fear that it would exceed the limits of its mechanical design. Their initial prototype is no longer available having reportedly been stolen. But they are currently constructing a second version in a laboratory in Moscow. Their test results should hopefully soon be made public.

Although the Searl Disc and MEC spontaneously generate energy, it is not clear that they necessarily violate the First Law of Thermodynamics since air temperature in their immediate vicinity is observed to drop. For example, when the MEC was operating, the air temperature was observed to decrease in proportion to the rotor's rpm, with the decrease

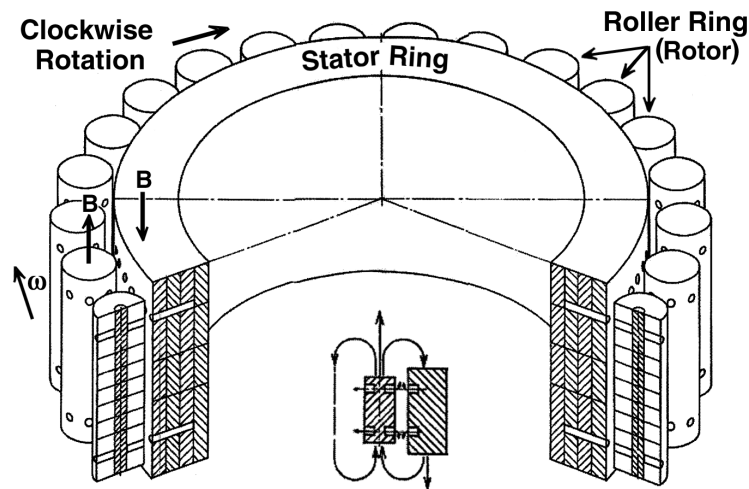

Figure 7. The Magnetic Energy Converter (courtesy of Roschin and Godin, 2002).

reaching 7.5° C at a rotor speed of 550 rpm, the temperature drop being confined to a set of nested cylindrical shells spaced at intervals of one rotor radius around the rotor's rotational axis. This stationary wave pattern suggests that the MEC (and Searl Disc) function as phase conjugate resonators allowing them to entrain energy from local molecular brownian motion and zero-point energy fluctuations, thereby decreasing the entropy of their environment. Of course, this challenges the Second Law of Thermodynamics. How the Searl Disc and MEC function as self-propelling engines and how they may be phase conjugating energy from their environment I have described in another paper.^{50,51}

Probably, much of the reason why the Searl effect has not received closer scrutiny by the physics community is due to the reported weight-loss/antigravity effect associated with it. Not only does this blatantly challenge the well established general theory of relativity, but standard physics in general is at a loss to explain the effect. Subquantum kinetics, however, offers a framework for easily understanding why a weight-loss and upward repulsive force would develop when the device is in operation. As the explanation is somewhat lengthy for this short review, the interested reader is advised to consult the above cited reference. Summarized briefly, the generator disc functions as a gravity screen locally reorienting the Earth's gravity field. The phenomenon is best understood by visualizing the ensuing paths of etheric flux. That is, the disc functions as an etheric pump as its resonantly oscillating electromagnetic field gradients propel X and G etherons outward and in so doing locally entrain and horizontally redirect the vertical G etheron flux that naturally streams into the Earth producing the Earth's gravity field. Certainly, the implications are incredible for applying this technology in the construction of air craft, space craft, and even ocean going vessels.

If physicists were willing to switch from their currently taught theories and concepts to the methodology of subquantum kinetics and the new concepts it entails, twenty-first century science could begin to undertake serious study of machines similar to the Searl Disc (or MEC) which could herald a fantastic new era for our world. Certainly, generators that cool their environment when they generate electricity should be of great value especially in such times as these where global warming poses a serious problem to our future.

Conclusion. If we are to search for the real people to blame for modern science's inability to come up with new environmentally friendly energy sources that will alleviate our current high cost of energy and diminish the risk of global warming, we need look no further than to seek out those pundits who preach from the pulpits of white tower academia. Our search will in the end bring us face to face with those self-appointed czars of contemporary physics and engineering who wield their power to criticize and suppress any rebel ideas that challenge their conventional wisdom. Those proposing controversial concepts are prevented from publishing their ideas in refereed journals by having their papers either sent back unreviewed or rejected without good cause. Their proposals seeking government funding for such research and their attempts to obtain patent protection for their ideas are rejected, not because their ideas are flawed or inconsistent with observation, but because they deviate from the accepted teachings of science. Furthermore to ensure that they do not pass on their deviant thinking to the unfettered and receptive minds of our youth, these individuals are repeatedly blocked from any attempt to obtain academic teaching positions. In short, we are being held in siege by a scientific Mafia, while society itself careens closer to the precipice of ultimate destruction.

The purpose of this paper has been to point out some examples of certain outmoded restrictive laws of physics and of technologies that blatantly violate them, technologies which could provide a way out of the deep hole that society has currently dug for itself. Contemporary physicists currently hold the future of our world in their hands. Will ivory tower pedants choose subservience to their current ideational icons and let their less than perfect world burn in disdain, or will they help these few heroes pull the rope that might save us from an avoidable hell?

References

1. Lafforgue, J.-C. "Isolated systems self-propelled by electrostatic forces." French patent No. 2651388, 1991.
2. LaViolette, P. A. "An introduction to subquantum kinetics: Part II. An open systems description of particles and fields," In *International Journal of General Systems, Special Issue on Systems Thinking in Physics* 11 (1985): 295–328.
3. LaViolette, P. A. *Subquantum Kinetics: A Systems Approach to Physics and Cosmology* (Schenectady, New York: Starlane Publications, 1994, 2003).
4. Ibid.
5. Ibid.
6. LaViolette, P. A. *Genesis of the Cosmos: The Ancient Science of Continuous Creation* (Rochester, VT, Bear & Co., 1995, 2004).
7. Överbjörk, B. "Warped Minds, Bent Truths," Eprint at: http://blog.hasslberger.com/2007/06/einstein_warped_minds_bent_tru.html.
8. Smolin, L. *The Trouble With Physics: The Rise of String Theory, the Fall of a Science, and What Comes Next*. (Houghton Mifflin, 2006).
9. Woit, P. *Not Even Wrong: The Failure of String Theory And the Search for Unity in Physical Law*. (Basic Books, 2006).
10. Naudin, J.-L. "The Lafforgue's field propulsion thruster solver." <http://jlnlabs.imars.com/lfpt/html/lfptslv2.htm>.
11. Brown, T. T. "Electrokinetic apparatus," U.S. patent #3,187,206, issued June 1, 1965.
12. LaViolette, P., *Secrets of Gravity Control*. (Rochester, VT, Bear & Co., 2008).
13. Ibid.
14. Brown, T. T. "How I control gravity," *Science and Invention Magazine*, August 1929; reprinted in *Psychic Observer* 37(1): 14-18; Eprint at: qualight.com/stress/control.htm.
15. P. Schatzkin *Defying Gravity*. Ch. 50 (2007); Eprint posted at: <http://www.ttbrown.com/>.
16. Ibid.
17. Cornille, P. "Newton's third principle in post-Newtonian physics," *Galilean Electrodynamics* (1999).
18. Cornille, P. "Electrostatic pendulum experiment which pumps energy from the ether," (1999). Unpublished research posted on J. Naudin's site: <http://members.aol.com/overunity/elecpep/elecpep.html>.
19. Cornille, P. "Review of the application of Newton's third law in physics," *Progress in Energy and Combustion Sciences* 25 (1999):161-210; <http://jnaudin.free.fr/elecpep/elecpep.html>.
20. Podkletnov, E. June 11, 2003, personal communication.
21. Podkletnov, E. and G. Modanese, "Investigation of high voltage discharges in low pressure gases through large ceramic superconducting electrodes," *Journal of Low Temperature Physics* 132 (2003):239-259; Eprint at: arXiv.org/abs/physics/0209051.

22. LaViolette, P. A. *Subquantum Kinetics*, 2003.
23. LaViolette, P. A., *Secrets of Gravity Control*, 2008.
24. Podkletnov, E. June 11, 2003, personal communication.
25. LaViolette, P. A., *Secrets of Gravity Control*, 2008.
26. Ibid.
27. LaViolette, P. A. "An introduction to subquantum kinetics: Part II," 1985.
28. LaViolette, P. A. *Subquantum Kinetics*, 1994, 2003.
29. LaViolette, P. A. *Genesis of the Cosmos*, 1995, 2004.
30. LaViolette, P. A. "Is the universe really expanding?" *Ap. J.* **301** (1986): 544 -553.
31. LaViolette, P. A. *Subquantum Kinetics*, 1994, 2003.
32. LaViolette, P. A. "The planetary-stellar mass-luminosity relation: Possible evidence of energy nonconservation?" *Physics Essays* 5 (4) (1992): 536–42.
33. LaViolette, P. A. *Subquantum Kinetics*, 1994, 2003.
34. LaViolette, P. A. "The Pioneer maser signal anomaly: Possible confirmation of spontaneous photon blueshifting," *Physics Essays* 18 (2) (2005):150-163; Eprint at: <http://arxiv.org/abs/physics/0603191.html> .
35. *Thermal and Nuclear Aspects of the Pd/D₂O System, Vol. 1: A Decade of Research at Navy Laboratories*. Tech. Rep. No. 1862. S. Szpak and P. Mosier-Boss eds. San Diego, CA: U.S. Navy, Feb. 2002.
36. LaViolette, P. A. "An introduction to subquantum kinetics: Part II," 1985.
37. LaViolette, P. A. *Subquantum Kinetics*, 1994, 2003.
38. Turing, A. "The chemical basis of morphogenesis." *Phil. Trans. Royal Soc. London B* **237**(641) (1952): 37-72.
39. Fleischman, M., personal communication, 1999.
40. Kelly, J. 2002, "Nucleon charge and magnetization densities from Sachs form factors." *Phys.Rev. C* **66** (6), id: 065203; Eprint at: <http://arXiv.org/abs/hep-ph/0204239>.
41. LaViolette, P. A. "The electric charge and magnetization distribution of the nucleon: A Turing wave pattern? (2005) submitted; Eprint at: <http://home.earthlink.net/~gravitics/Downloads/nucleon.html> .
42. Pappas, P. T. "Excess free energy and cold nuclear fusion." *Twenty-First Cen. Tech.*, Jan.-Feb. (1990):11-12.
43. Baard, E. "The empire strikes back." *Village Voice*, April 25, 2000
44. Mills, R. and Ray, P. "Extreme ultraviolet spectroscopy of helium-hydrogen plasma." *Journal of Physics D: Applied Physics* **36** (2003): 1535-1542.
45. LaViolette. P. "An introduction to subquantum kinetics: Part II," 1985.
46. LaViolette. P. "The electric charge and magnetization distribution of the nucleon," 2007.
47. <http://www.rexresearch.com/mra/1mra.htm>; <http://www.rexresearch.com/mra/2mra.htm>
48. Sandberg, S. G. "Searl-effect generator: Design and manufacturing procedure," June 1985; Eprint at: www.rexresearch.com/research/Searl/searl.htm .
49. Roshchin, V. V., and S. M. Godin, "An experimental investigation of the physical effects in a dynamic magnetic system," *Technical Physics Letters* **26** (2000):1105 - 1107; Eprint at: http://users.erols.com/iri/Roshchin_Godin.PDF.
50. LaViolette, P., "How the Searl Effect Works: An Analysis of the Magnetic Energy Converter." Eprint posted at <http://www.etheric.com/Downloads/MEC.html>.
51. LaViolette, P., *Secrets of Gravity Control*, 2008.